



**FX 27**

**Zero Turn**

Hydrostatic ride-on mower with mulching and rear discharge cutting deck

**Grillo**  
AGRIGARDEN MACHINES

# FX 27

## Grillo guarantees the reliability and quality of its products



Grillo designs and builds quality machines to improve work and make it more comfortable. The company strives for continuous improvement through innovation, leading to very high standards in terms of quality and reliability. All this is combined with our excellent customer and spare parts service which allows Grillo products to retain their value over time.



# FX 27

A step forward in the Zero Turn category



**The FX 27 Zero Turn... developed from our experience.**

A mix of new features and quality components, designed to easily cut areas with many obstacles achieving an exceptional finish with maximum manoeuvrability and speed. It is ideal for both the private owner and the professional user who needs to work quickly and efficiently.

The twin-levers control system reduces the turning radius to zero and guarantees fast and effective manoeuvres even in the most difficult conditions, thanks to the built-in stability and balance mechanism.

# FX 27

A front cutting deck allows greater visibility over the working area



The FX 27 is a front deck mower enhancing all the advantages of a ZERO TURN, such as higher manoeuvrability and reduced working time.

The front cutting deck makes it easier to approach obstacles with greater visibility over the whole working area. In gardens with many bushes, hedges, small walls, trees, etc. the need for a time consuming trimmer will be considerably reduced.

# FX 27

## The advantages of a Zero Turn enhanced by a functional design

The machine weight is shifted over the driving axle thereby increasing its grip on the ground. Its large wheels reduce ground pressure preventing the machine from damaging the grass when it stops, starts or turns quickly.

The tapered shape of the fuel tanks and the protruding cutting deck allow the operator to get closer to small walls, hedges or curbs without hitting the rear bumper during these operations thus achieving excellent finishes.

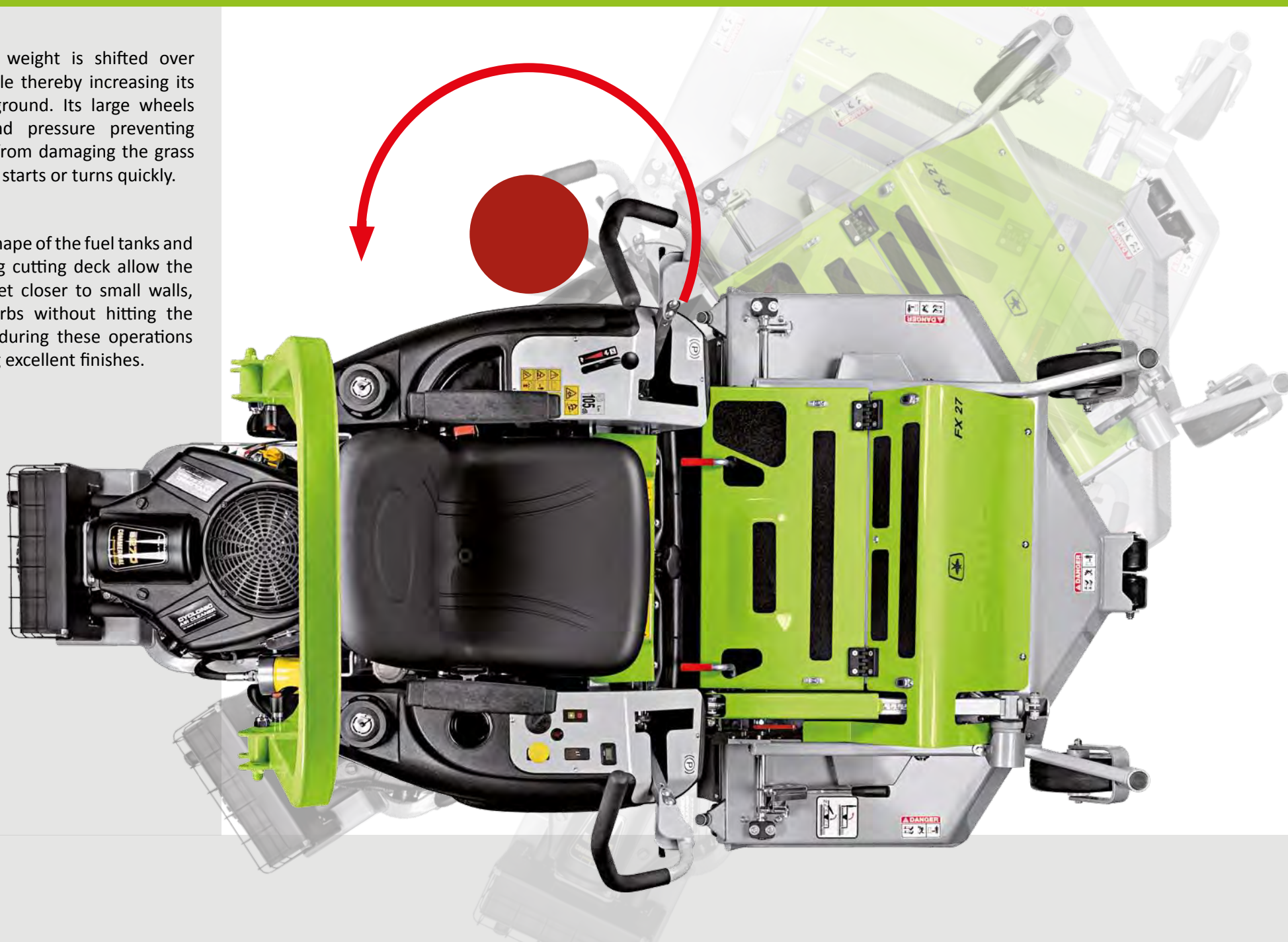

# FX 27

A professional mower, reliable and with excellent stability



Another important feature of the **FX 27** is its automatic stability and balance device on slopes. Thanks to a stabilising hydraulic cylinder activated automatically, this device reduces the risk of the rear wheel raising on downhill slopes and when braking.

This mechanism reduces the weight on the rear wheel, thus maintaining a stable driving condition even when performing quick manoeuvres. The drive system is excellent for mowing on slopes maintaining good adherence to the ground.

# FX 27

## Mulching or rear discharge in one easy step!



The FX 27 is also suitable for large areas where a high quality mulch cut is required. The cutting deck delivers an excellent finish even at high speed, making it possible to mow large areas very quickly.



The **FX 27** is a mower very suitable for any kind of ground thanks to its quick and easy selection of cutting modes.

The cutting deck is activated by an electromagnetic clutch and is equipped with three blades giving a working width of 125 cm.

The switch from rear discharge to mulching is centralised and quick. A lever allows the operator to choose the most suitable cut without having to leave their seat.

CUTTING MODE SELECTED VIA LEVER, NO NEED TO CHANGE BLADES OR REMOVE BAFFLES

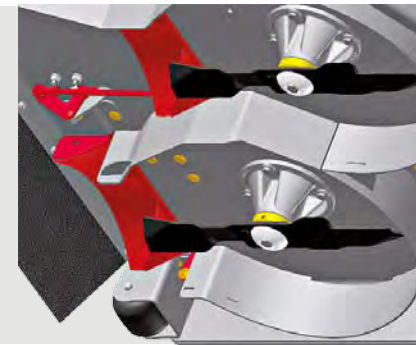

**A** REAR DISCHARGE MODE  
CUTTING CHAMBER OPEN



**B** MULCHING MODE  
CUTTING CHAMBER CLOSED

# FX 27 Cutting deck and machine frame articulated and independent

The **FX 27** is fitted with a petrol Briggs&Stratton series 8270 engine with exceptional performance. The twin fuel tanks (15 litres each) are fitted symmetrically over the wheels, ensuring optimal weight distribution and autonomy.

The transmission is hydrostatic with integrated motors and pumps, with a speed range of 0 to 12 km/h. The blade engagement clutch is electromagnetic and complete with safety brake.

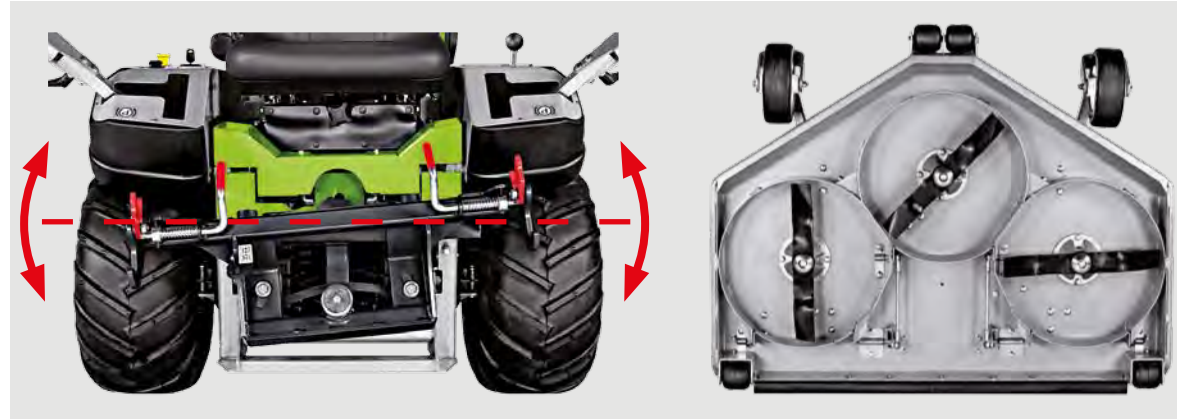

The cutting deck has three blades made of high tensile steel. The blades are fastened to robust alloy hubs with bolts and Belleville washers that protect them from any impact.

Both the cutting deck and machine frame are articulated and pivot independently horizontally and vertically. This makes it possible for the cutting deck to adapt to any ground irregularities.

The solid front wheels prevent punctures. The height of the anti-scalp wheels can be adjusted to ensure greater stability on the ground and to avoid damaging the grass.





# FX 27

## Excellent comfort, easy and safe controls with quick adjustments

A pneumatic dampened seat is available as an option.



The machine can also be fitted with a double-wheel axle to facilitate loading on to a trailer.

It can also be equipped with tractor type wheels, necessary when the ground is particularly difficult and steep.



Operating the **FX 27** is a comfortable experience thanks to the spacious and adjustable driver's seat, equipped with armrests and an ergonomic platform. The driving levers are also adjustable and are extremely smooth and soft to operate. All controls are within reach. The parking brake engages automatically when the operator opens the driving levers, keeping the engine running should the operator get off the seat.

Roll-bar and safety belts as standard equipment. The roll-bar can be folded without additional tools.

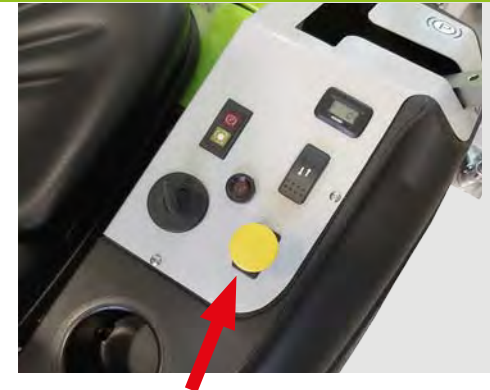

Electromagnetic clutch for blade engagement.

The cutting height is adjusted via a push button on the dashboard, there is no need for the operator to get off the seat. The cutting height can be continuously adjusted from a minimum of 3 cm to a maximum of 8,5 cm.

# FX 27

## Maintenance made easy for everyone!

Anyone can easily carry out maintenance on the **FX 27** cutting deck. It can be raised into the maintenance position via a push button with no need to remove the belt.



Cleaning the cutting deck in its raised position is quick and easy.



The driver's seat can be tilted with the aid of a gas spring allowing inspection and maintenance of the machine. Lubrication points are clearly marked and within reach.



# FX 27

Values that make the difference beyond the product!



## Grillo Technical Assistance

Efficient, practical pre and after sales service with a single goal: to always give our Customers quick, efficient answers.

**Guarantee and Spare parts Service**

Guaranteed machines. Spare parts service with fast delivery times: **value guaranteed over time.**

**GTS Grillo Top Service**

**Grillo Top Service**









On-site presentation and demonstration.

## GRILLO DEALERS

Specialised stores around the country are able to understand your specific needs to guide you towards the right choice.

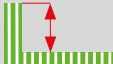
You will be met with quality, courtesy and a chance to view and try all Grillo products.

info - [www.grilloagrigarden.co.uk](http://www.grilloagrigarden.co.uk)

	Briggs & Stratton Series 8270 Commercial	Power 22 HP (16.2 kW) 724 cc with 2 cylinders, air-cooled Dry air filter with replaceable cartridge
	30 L	Twin petrol tanks with a total capacity of 30 litres with level indicator
 HYDROSTATIC	0 - 12 km/h	Twin hydrostatic transmission with integrated pump and Hydro Gear motor Driving wheels 20x10.00-8 Turning rear wheel 15x6.00-6 Solid anti-puncture front tyres 9.00x3.50-4
	ZERO TURNING	Drive controlled by levers, zero turning radius Parking brake engaged by opening the driving levers
	3...8,5 cm	Continuous adjustment of the cutting height from 3 to 8,5 cm Electric raising of the cutting deck for maintenance and cleaning
	125 cm	Cutting deck with 3 blades, total deck width 132 cm, cutting width 125 cm Possibility to switch from rear discharge to mulching mode with a lever from the driver's seat Blade engagement via electromagnetic clutch
	484 kg	Total machine weight 484 kg
	ACCESSORIES	Tractor wheels, Double-wheel axle, Snow Chains for wheels 20x10.00-8, Pneumatic dampened seat
	LpA 89 dB(A)	Noise level: acoustic pressure at the driver's seat.

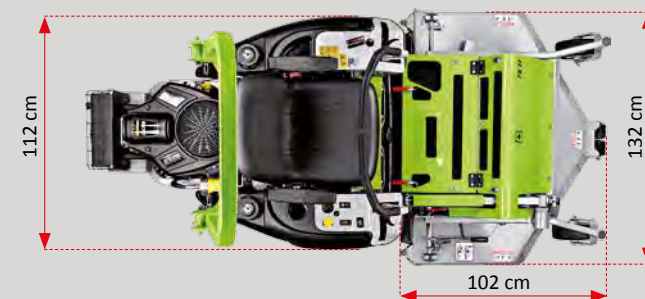

### GRILLO SPA

Via Cervese, 1701 - 47521 CESENA (Italy)

Tel. (0039) 0547 633111 - Fax (0039) 0547 632011

Internet: [www.grillospa.it](http://www.grillospa.it)

E-mail: [grillo@grillospa.it](mailto:grillo@grillospa.it)

[www.grilloagrigarden.co.uk](http://www.grilloagrigarden.co.uk)

[www.grillofrance.fr](http://www.grillofrance.fr)

[www.grillodeutschland.de](http://www.grillodeutschland.de)

[www.grilloaustralia.com.au](http://www.grilloaustralia.com.au)

[www.grilloagrigarden.ru](http://www.grilloagrigarden.ru)